

ZYQ12210增压器外形尺寸图

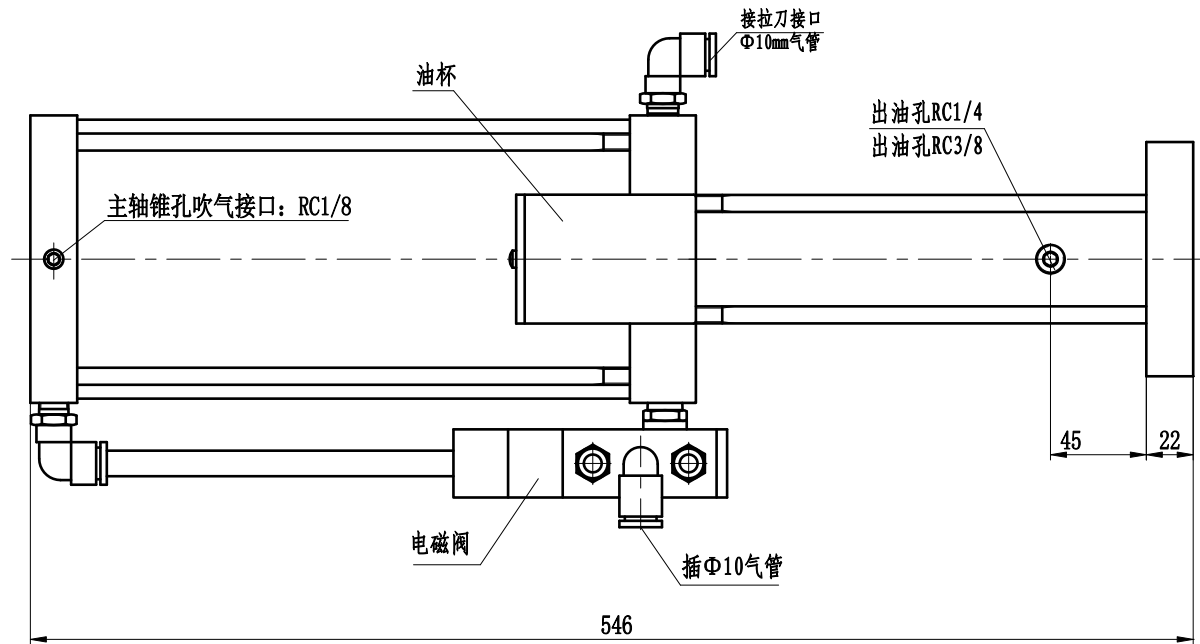
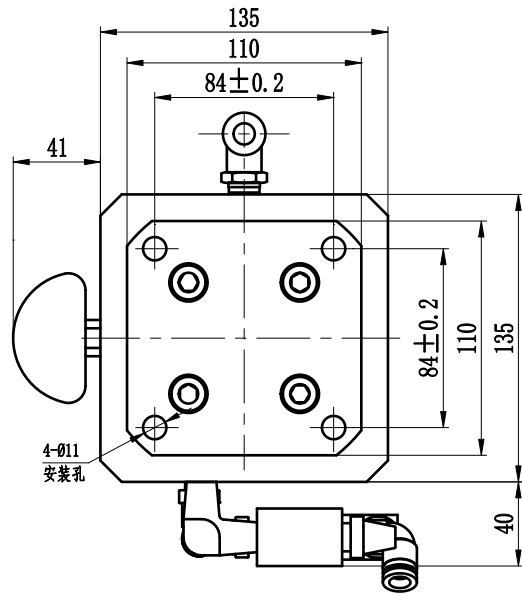

增压比: 1:12.7

出油量: 210CC